



灵江工控

LBOX-QM77

用户手册



目录

引言	3-4
产品介绍	5
产品调试	6
安装指南	7
使用说明	8
使用与保养	8
功能说明	9
1. DC电源供电	9
2. 开关	10
3. 网络	10
4. USB	10
5. 显示接口	11
6. 串口(COM)	12
7. 音频.....	13
8.PCIE卡安装	13-14
9.其他选配.....	15-18
系统安装	19
常用功能设置步骤	20
看门狗(Watchdog)编程代码.....	21-28
GPIO代码	29-31
BIOS设置	32-44

引言

版本

2015 年 2 月

修订：B-2

版权保护及声明

本手册为深圳灵江计算机技术有限公司的知识产权，内容受版权保护。未经许可不得以机械的、电子的或其他任何方式进行复制。除列明随产品配置的配件外，本手册包含的内容并不代表本公司的承诺，我们非常小心地编写此手册，但我们对于本手册的内容不保证完全准确，因为我们的产品一直在持续地改良及更新，故我方保留随时做出修改而不予另行通知的权利。

对于任何安装、使用不当而导致的直接的、间接、有意或无意的损坏及隐患概不负责。您在订购产品前，请向销售人员了解好产品的配置是否满足您的要求。

商标

本手册使用的所有商标均属于各自的商标持有者所有：

Intel和Pentium以及Celeron是Intel Corporation的注册商标

PS/2和OS/2是IBM Corporation的注册商标

Windows98和WindowsXP是Microsoft的注册商标

Netware是Novell 的注册商标

Award是Phoenix Technologies, Inc的注册商标

AMI是American Megatrends, Inc的注册商标

阅读说明

此手册中“灰底黑色字体”的内容为提示需注意的内容，“灰底红色字体”的内容为产品选配的内容。

其他文字为常规描述，所插图片、图标和表格为相应接口、功能的附图说明，产品以实物为准。

产品质保（一年）

从购买之日起，我公司提供一年的产品质保，但对未经我司允许而擅自维修过的产品并不进行品质保修。我公司对于不正确的使用、自然灾害、错误安装产品导致的问题有免责权利。

如果产品出现故障，在质保期内我们提供免费维修或更换服务。对于过保产品，我们将会酌情收取材料费、人工服务费用。请联系您的销售人员了解详细情况。

如果您认为您购买的产品出现了故障，请遵循以下步骤：

- 1、收集您所遇到的问题的资讯（例如：CPU主频、使用的产品及其它软件、硬件），请注意品质保证。
- 2、致电联系我司售后工程师，描述故障现象，并借助此手册和与产品有关的任何说明资讯来解决问题。
- 3、如果您的产品被诊断发生故障，请您寄回我公司，我们尽快地进行故障产品的维修。
- 4、请仔细地包装故障产品，并在包装中附上清楚的故障现象文字描述以便我们准确的进行维修。
- 5、我们将在1~5个工作日内寄回产品，并在包装中附上完整的产品故障诊断结果。

符合性声明

CE FCC ROHS

本产品已通过CE、FCC、ROHS测试，符合以遮罩电缆进行外部接线的环境规格标准。建议用户使用遮罩电缆，此种电缆可从自行购买。本产品通过CE环境规格检测，测试条件之一是在工业环境中进行产品操作，为了使产品免受ESD（静电放电）和EMI泄露造成的损害，强烈建议用户使用符合CE标准的工业产品。

根据FCC条例第15款，本产品已经通过检测并被判定符合B级数位产品标准，这些限制旨在为运行环境下的系统操作提供合理保证，使其免受有害干扰。本产品在使用中会产生和发射无线电频率能量，如果没有按照此手册说明正确安装和使用，可能对无线电通讯造成有害干扰。但即使按照手册说明进行安装和使用，也不能保证不会产生干扰。若本产品曾对无线电或电视信号接收产生有害干扰，用户可通过开关设备进行确认。当本设备产生有害干扰时，用户可采取下面的措施来解决干扰问题：

- 1) 调整接收天线方向或位置
- 2) 增大本设备与接收器之间的距离
- 3) 将本设备的电源接头插在与接收器使用不同电路的电源插座
- 4) 若需技术支持，请咨询技术人员

技术支持与服务

1. 想了解更多的产品信息及关注产品更新，请访问我司官方网站了解并下载相关资料。

<http://www.ling-jiang.com/>

2. 用户若需要技术支持，请与我公司技术人员联系（电话：0755-23448870-8016）。

进行技术咨询前，请告知我司技术人员以下信息：

- 1) . 产品名称及型号
- 2) . 用户单位名称
- 3) . 您所咨询的技术内容或者使用产品的故障现象描述

产品介绍

LBOX-QM77是灵江工控自主研发的第六代无风扇工控主机,本产品采用无风扇散热结构,新增了1个标准PCIE扩展功槽,产品采用规格为161*180(mm)的工控主板,主板采用Intel QM77芯片组,可上I3, I5, I7CPU。

LBOX-QM77工控机内部结构整齐紧密,适用于车载行业、耐高温等恶劣工业环境中的使用. 产品支持9V-25V之间的宽压供电,可在零下20度至高温60度的环境中长时间稳定运行. LBOX-QM77的最大体积为 250.89 x 165.5 x 100mm ,净重量不足3.5kg,产品设计方案较灵活方便,本公司可以根据用户的需求全方位定制,提供用户最满意、最适用的产品. 用户可以上英特尔网站了解选择支持QM77芯片组的其他CPU,产品支持XP、win7、win8等主流系统.

产品接口丰富,标配2个千兆网口,6个串口(其中有1个RS485),VGA与HDMI双显输出,8个USB. 产品标配2G内存,硬盘标配16G固态硬盘,用户可选择2.5寸笔记本硬盘120G、160G、320G、500G等机械硬盘和SSD32G、64G、128G、256G等大容量硬盘,产品标配铝合金银白色机壳.

选购清单:

	标准配置	选择配置
LBOX-QM77	银色/ 2G内存/ 16G硬盘/ XP系统/8个USB/ 2个网口 1个RS485/ 5个RS232/ VGA / HDMI/ 音频孔/ 1*PCIE GPIO/DC12V电源	黑色机壳/4G、8G内存/ 32G、64G等大硬盘 WIN7 WIN8系统/ 内置喇叭/ 3G、wifi功能

注: 产品标配不带CPU, 可选I3 3110M CPU, I5 3210M CPU, I7 3610QM CPU, 或其他CPU。



产品调试

用前检查

请确认您所购买的产品包装盒是否完整,如果包装有所损坏、或是有任何配件欠缺的情形,请尽快与我们联系。

产品标准配件如下:

- 1台工控主机
- 用户手册(非纸质资料,电子文件版可在线传输或网上下载)
- 1个12V电源适配器
- RS485接头,GPIO接头
- 1张保修卡
- 合格证

如用户在订购时有特别要求的,可以根据相关订单(合同)检查其他配件是否配齐。

初始测试准备

产品调试前,用户需准备以下配件:

- 液晶显示器
- USB接口式键盘
- USB接口式鼠标
- PCIE扩展卡
- 220V电源排插或插座

! 如用户不使用产品标配的电源适配器,而采用外接电池供电,则需准备好连接电线和电池,参照本手册产品电源正负极接好即可使用。

调试步骤

1. 将产品放置在平整的工作台上,检查各接口处是否有杂物。
2. 将电源线的母型接头连接至产品的DC接口。
3. 将电源线的3针公型接头连接至电源插座。
4. 用VGA转接线将显示器与工控机连接。
5. 按下工控机上的触摸开关即可开机。
6. 将键盘和鼠标连接至电脑的USB接口。
7. 手动检查产品的内存、硬盘、系统等是否和订购的要求一致。
8. 将需要运行的应用软件装到电脑上进行调试运行。
9. 运行一段时间后,如产品无异常则可以直接安装使用;如在调试中发现异常请先检查排除软件与硬件是否匹配,如确认属产品硬件的问题,可以联系厂家技术服务(0755-23448870-8016)。



安装指南

1. 安装前，请先熟悉产品的结构图纸及所选用的安装方式与产品是否匹配.
2. 产品出厂不配各种安装架和安装使用的配件、螺丝等.

因产品实物与图纸有误差，建议实际安装以收到实物为准.

标配尺寸规格

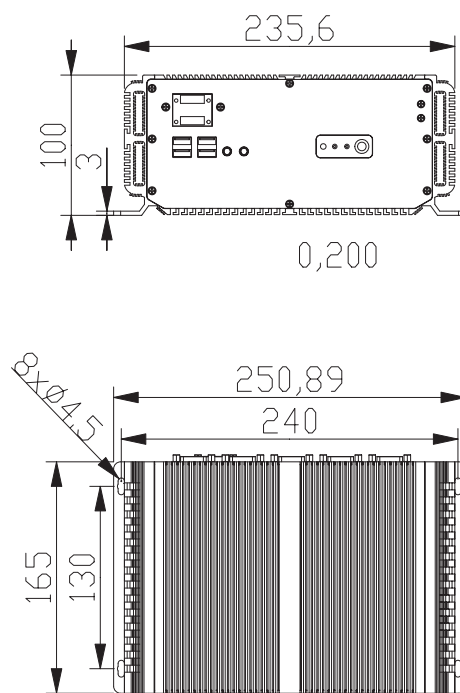



使用说明

●使用与保养

1. 请仔细阅读此用户手册并妥善保存此用户手册以供日后参考。
2. 调试安装前确保此设备放置在可靠的平面上，意外跌落可能会导致损坏外观。
3. 连接此设备到电源插座前，请确认电源插座的电压是否符合要求。
4. 请将电源线布置在人员不易绊到的位置，并不要在电源线上覆盖任何杂物。
5. 如果长时间不使用此设备，请将其同电源插座断开，避免设备被超标的电压波动损坏。
6. 此设备采用铝合金拉丝材质，使用过程中请勿用尖锐的东西接触产品以防刮伤。
7. 如有尘埃、水滴和杂物掉落接口，请及时小心清除以防影响使用效果。
8. 用湿抹布清洗设备前，请从插座拔下电源线，请不要使用液体或支渍喷雾剂清洗设备。
9. 请不要在过度潮湿的环境中使用此设备。
10. 请不要自行打开设备，为了确保您的安全，请由经过专业认证的工程师来打开设备。
11. 此设备机壳上有缝隙，请不要让任何液体流入孔内，以免主板短路引起火灾或设备损坏。
12. 请不要把设备放置在超出我司产品标准的环境温度范围，即不要低于-20度，或者高于60度。
13. 用户如更换电源供电方式，请提供与我司产品规格相配的电源及供电方式，注意供电电压不能超过我司产品的标准范围（9V-25V），否则可能会损坏设备。
14. 定期检查设备的电源接口、网口、串口、USB接口、VGA接口等是否松动。
15. 用户在使用此设备连接其他设备时，串口、USB、VGA等接线插拔要小心，以防过度用力损坏接口。
16. 在此设备上安装3G卡、PCIE卡或接通天线时，需先关机断开电源。
17. 当此设备正在运行时机壳温度过高切勿用手去触摸机壳。
18. 使用过程中如发生不确定的异常现象时，切勿擅自拆机维修，要及时联系技术人员来解决。

●功能说明

1. DC电源供电

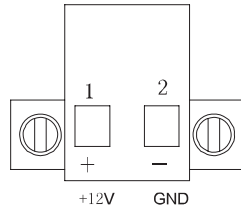

DC Connect

管脚	信号名称	管脚	信号名称
1	+12V	2	GND

工控机采用2Pin凤凰端子电源供电口，左边为正极（靠VGA），右边为负极。连接电源前请注意正负极。



- 产品标配带有1个12V5A（可选8A）的电源适配器和1条3脚国标电源插头线。
- 用户使用前需检查配件是否齐全并查看电源外观及电线有无损坏。
- 电源接头与设备对接时请注意对接方向，请勿用力插拔以免损坏接口。
- 用户需使用其他供电方式时，可以将电源接头拆除然后接上软电线，请注意正负极。
- 用外接电池或电频来直接供电时，请注意电压必须保持在安全电压9V-25V之间。

2. 开关



产品标配薄膜触摸开关，轻按红色键即为开机。

面板提供 1 组电源、硬盘状态指示灯，可通过前面板上的电源、硬盘状态指示灯便能及时的了解计算机当前的运行状态。

绿灯常亮时说明计算机当前正常接入并处于开启电源状态
红灯闪烁时，说明计算机的硬盘存储器处于读写数据状态。

3. 网络

产品标配有二个千兆网口，可连接外部网路设备.2个千兆网口采用英特尔芯片组,支持网络引导启动和网络唤醒功能.
RJ-45 以太网接口两侧共有两盏状态指示灯：

左—链路状态指示灯
L-LED

右—数据传输指示灯
R-LED

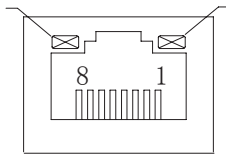

LAN1 Intel® 82579LM,
LAN2 Intel® 82583V

LAN1-2	
Pin	10/100/1000BaseT Signal Name
1	TX+
2	TX-
3	RX+
4	MDI2+
5	MDI2-
6	RX-
7	MDI3+
8	MDI3-

网络状态	左 (LILED) 双色 (橙/绿色灯)		右 (ACTLED) 单色 (黄色灯)	
1000M	常亮		闪烁	灭
100M			闪烁	灭
10M	灭	灭	闪烁	灭
活动描述	绿色	橙色	数据传输	无数据传输
	已连接状态指示灯		活动状态指示灯	

产品出厂不配相关网络接线，用户需自购网线。

4. USB接口

工控机标配带有4个USB3.0接口和4个USB2.0接口，可连接8个外部USB设备。

USB 3.0 Connector

管脚	信号名称	管脚	信号名称
1	+5V	2	USB_data-
3	USB_data+	4	GND
5	SSRX-	6	SSRX+
7	GND	8	SSTX-
9	SSTX+		

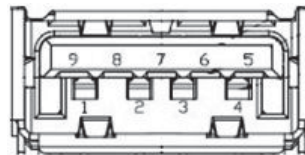

USB 2.0 Connector

Pin	Signal Name	Pin	Signal Name
1	+5V	2	USB_data-
3	USB_data+	4	GND

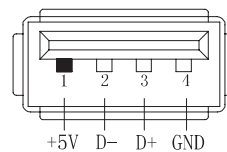

a. USB接口支持热插拔，使用USB设备前请先安装设备驱动。

b. 产品出厂不配USB转接线和USB接口的鼠标与键盘等，用户需要时需自购。

5. 显示接口

工控机标配有一个HDMI、一个DP和一个VGA接口，可连接外部显示设备。

1). HDMI接口

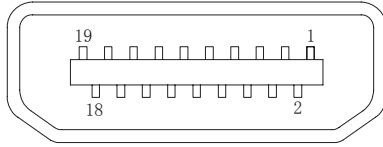

产品出厂不配显示转接线和其他设备，
需用户自备！

HDMI Connect

管脚	信号名称	管脚	信号名称
1	TMDS Data 2+	2	TMDS Data 2 shield
3	TMDS Data 2-	4	TMDS Data 1+
5	TMDS Data 1 shield	6	TMDS Data 1-
7	TMDS Data 0+	8	TMDS Data 0 shield
9	TMDS Data 0-	10	TMDS clock+
11	TMDS clock shield	12	TMDS clock-
13	CEC	14	Reserved
15	SCL	16	SDA
17	DDC/CEC Ground	18	+5V
19	Hot Plug Detect		

2). VGA接口

工控机标配有一个15针的VGA接口，可连接外部显示设备。

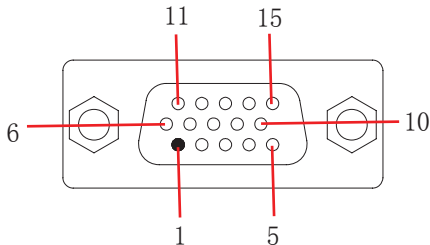

VGA Connect

管脚	信号名称	管脚	信号名称
1	RED	2	GREEN
3	BLUE	4	NC
5	GND	6	GND
7	GND	8	GND
9	+5V	10	GND
11	NC	12	DDCD_ATA
13	HSYNC	14	VSYSN
15	DDC_CLK		

3). DP接口

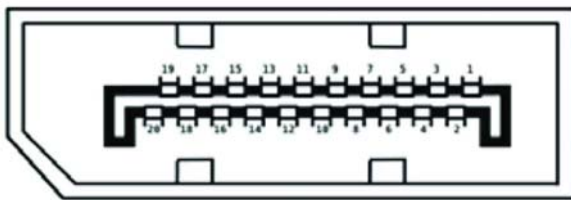

DisplayPort

管脚	信号名称	管脚	信号名称
1	ML_Lane 0 (p)	2	GND
3	ML_Lane 0 (n)	4	ML_Lane 1 (p)
5	GND	6	ML_Lane 1 (n)
7	ML_Lane 2 (p)	8	GND
10	ML_Lane 2 (n)	11	ML_Lane 3 (p)
12	GND	12	ML_Lane 3 (n)
13	GND	14	GND
15	AUX CH (p)	16	GND
17	AUX CH (n)	18	Hot Plug
19	GND	20	DP_PWR

- 产品出厂不配显示转接线和显示接口的其他设备，用户需要时需自购。
- 产品出厂默认VGA单显，如用户需要用到多显时，需安装相应驱动，并在Bios里面设置多显功能。
如无法设置或者操作失误的请联系售后服务电话0755-23448870-8016
- 产品主板芯片支持VGA与LVDS双显，使用过程中有时会出现显示跳屏的现象，即显示跳转至LVDS上面，此时需要用户进BIOS里面设置转换过来。具体设置见此手册《常用功能设置》。
- 产品支持2个VGA，可以将主板上LVDS的信号通过LVDS转接VGA的方式转成VGA输出。如需用到2个VGA的情况可在产品订购前说明选配。



6. 串口(COM)

工控机标配1个RS485串口和5个RS232串口。

1) .COM1 RS485

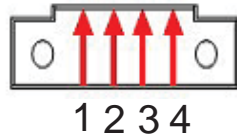

COM1 (485/422)

Pin	RS-422	RS-485
	Signal Name	Signal Name
1	TXD-	Tx-
2	RXD-	
3	RXD+	
4	TXD+	TXD+

- a. 产品出厂包装附件里面配标有1个RS485接头，不配连接线
- b. 用户接线时注意接口处的箭头方向准确选择1针 (+) 和4针 (-)
- c. 用户使用RS485时需注意针脚定义不能接反
- d. 如使用RS422的情况请接2针和3针（需要跳线即可请订购前要说明）

2) .COM2-COM6 RS232

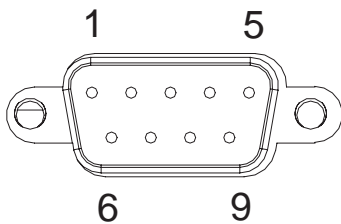

COM2-6(232/485)

Pin	RS-232	RS-485
	Signal Name	Signal Name
1	DCD	
2	RxD	Tx+
3	TxD	Tx-
4	DTR	
5	GND	
6	DSR	
7	RTS	
8	CTS	
9	RI	

工控机出厂默认标配5个DB9针的RS232接口。

- a. 产品出厂不配串口连接线和其它串口设备，用户需要自购。
- b. 连接串口时需断开工控机和其它周边设备的电源。
- c. 将串行设备的介面电线连接至工控机的串口上，
将介面电线的另一端连接至串行设备上，然后拧紧螺丝。
- d. 连接好设备后接通工控机和其它周边设备的电源。
- e. 请参考串行设备附带的指导手册来配合操作以辨别串行设备。

选配：

- a. COM2-COM6可选择RS485, 需订购前选定，出厂将调为RS485模式。
- b. 用RS485时请选择DB9针式串口的第2针 (+) 和第3针 (-) 来接线的。
- c. 如用户的使用环境震动比较强烈的情况，可以选择航空接头式的串口。用此接头需要订购时选定将修改机壳。

7. 音频

产品标配提供 1 个标准 Ø3.5 PhoneJack 音频输出接口 (LINE_OUT)、1 个 Ø3.5 PhoneJack MIC 输入接口 (MIC_IN)，客户可以直接连接音频设备使用。

产品出厂不配耳机线和外接音响设备，用户需自备。

选配：补加2个2W功耗的内接喇叭。
需在订购前选定，出厂机壳做喇叭孔。



Audio Conne	
Pin	Audio Signal Name
1	Line out
2	Mic in

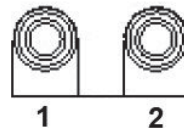

8. PCIE槽

产品默认标配1个CPIE槽.

产品出厂不配有PCIE的插卡和扩展卡，需用户自备。

如用户需安装PCIE扩展卡、数据采集卡、运动卡时，需准备好螺丝刀并打开机壳自行安装，拆机安装步骤如下：



在拆机、安装设备前，请确认已经关闭电源或拔掉电源线！

第1步：如右图，松开开关面的6个十字头螺丝，即可取下此面板。取下面板时要轻慢，注意触摸开关与主板的连接。

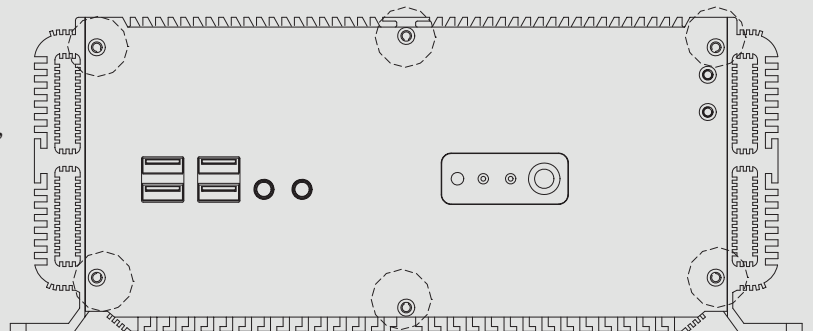

第2步：如右图，松开上面中间位置的螺丝，PCI槽边上的4个螺丝也需要拆下。

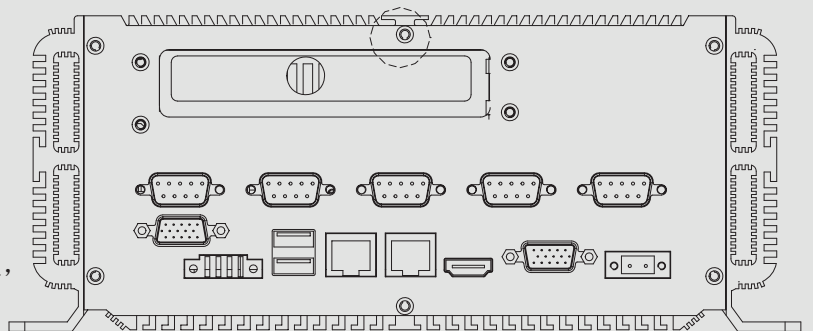

如需整体拆机时，则需要拆下全部螺丝，包括串口螺丝、VGA螺丝等。



开关面

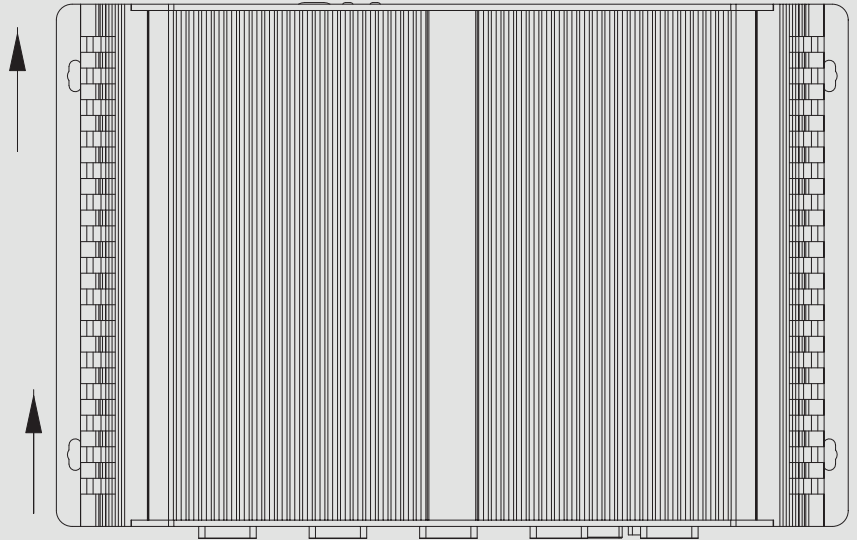

第3步：如右图，小心用力向开关面这边
抽取上面的盖板 即可取下顶盖

第4步：将需要安装的PCI卡插到PCI槽上。
组装时按相反步聚即可。

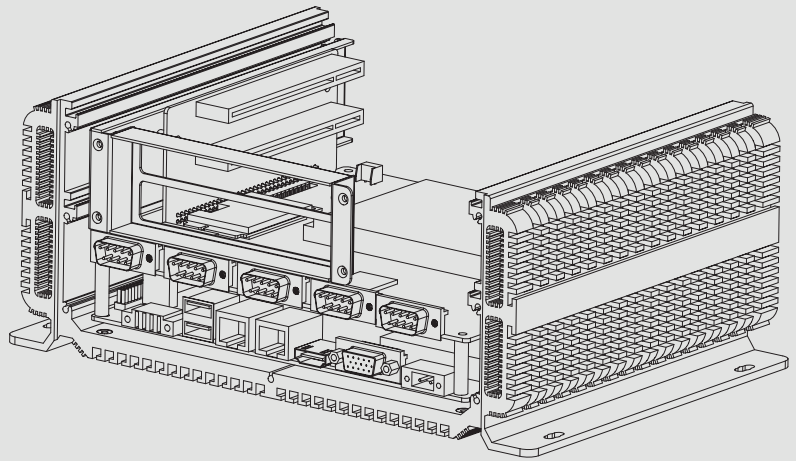



9.其他选配

1). 加配3G模块/wifi模块

- a. 产品主板提供2个标准的MPCIE接口，可用来安装符合标准的MPCIE设备.
- b. 如用户需要到3G上网功能、wifi上网功能，可在订购前选定，产品出厂前将加配此功能，并配有信号天线.
3G功能可选用联通或者电信，出厂将配相应的模块和驱动.(3G模块的品牌型号可由用户自己指定)
- c. 如需要GPS功能时，可选定同时兼容3G与GPS的模块.
- d. 如需要蓝牙功能时，可选定同时兼容wifi与蓝牙的模块.
- e. 信号天线可选2m长的吸盘天线和直杆短天线.



- f. 装取3G卡时需打开机壳背面的SIM卡位挡板.





2). GPIO

产品主板提供1个10接针的8位GPIO（4进4出），如用户需要GPIO功能时可以订购前选定，产品出厂前将从主板上用连接线引出至机壳，外接口模式为DB9针模式. GPIO程序代码见此手册.

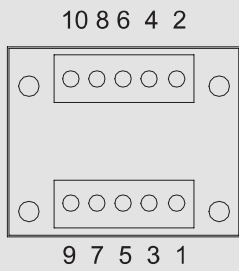
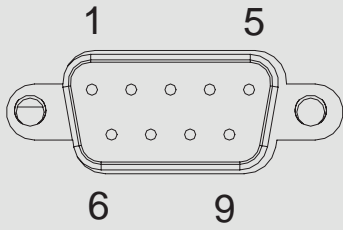

DIO Conn			
Pin	Signal Name	Pin	Signal Name
1	INPUT0	2	OUTPUT0
3	INPUT1	4	OUTPUT1
5	INPUT2	6	OUTPUT2
7	INPUT3	8	OUTPUT3
9	GND	10	5V

机箱拆装

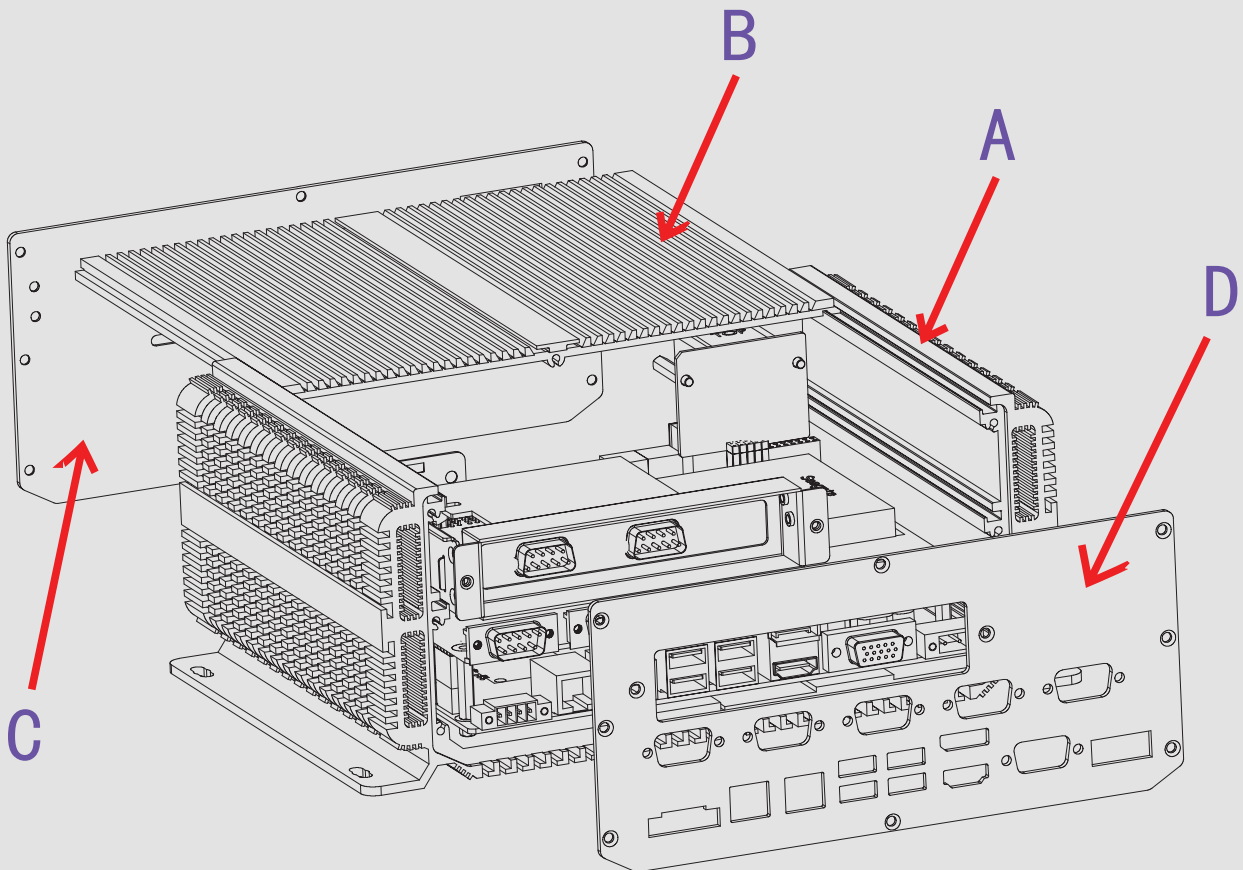

1. 机箱分4大部分组成：A：主箱体 B：盖板 C：前面板 D：后面板（I/O）；
2. 后面板：10颗螺丝+6颗COM螺丝；
3. 盖板：可向后面板、前面板方向推出；
4. 前面板：8颗螺丝（取下前面板时，请注意将薄膜开关取下后，再取下面板）；
5. 工具：M3螺丝刀；

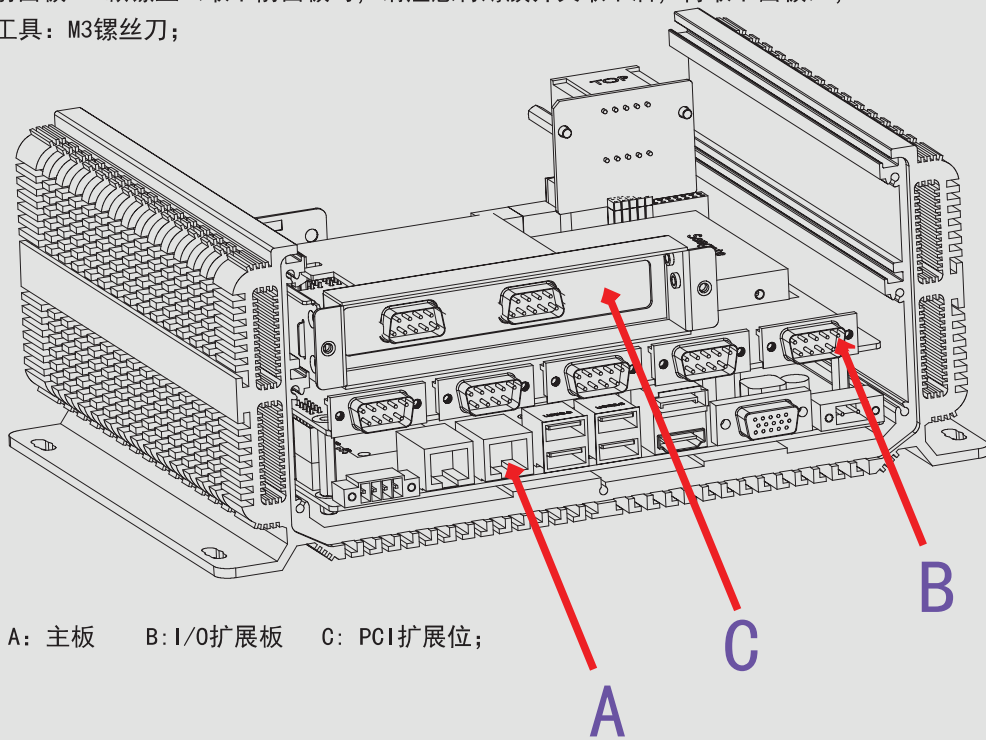

1. A：主板 B：I/O扩展板 C：PCI扩展位；

PCIE-4X扩展卡安装

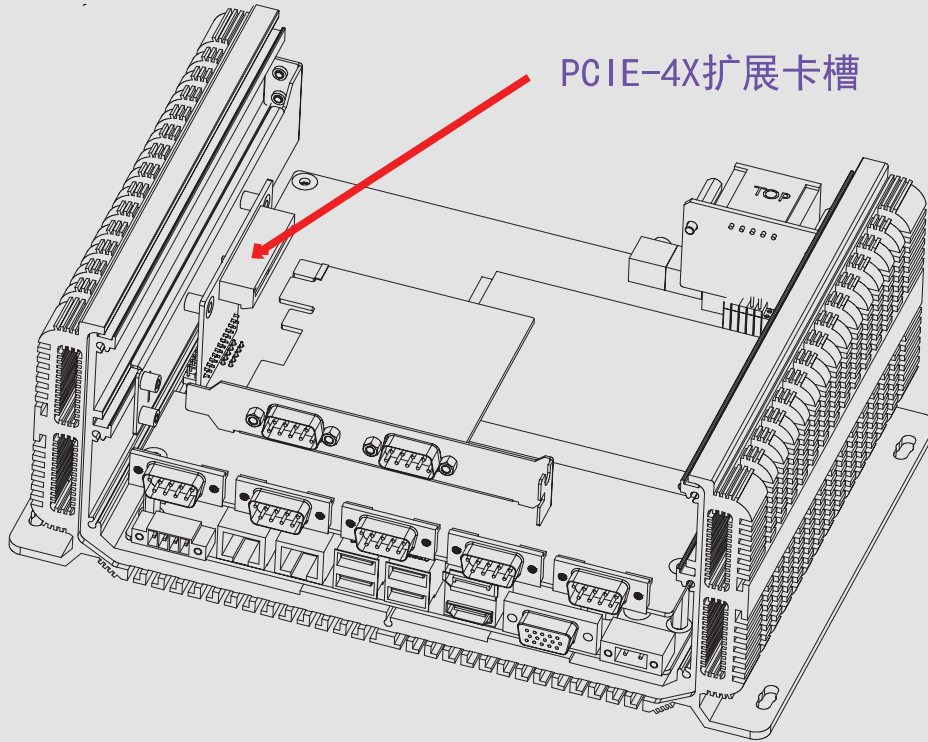

内存安装

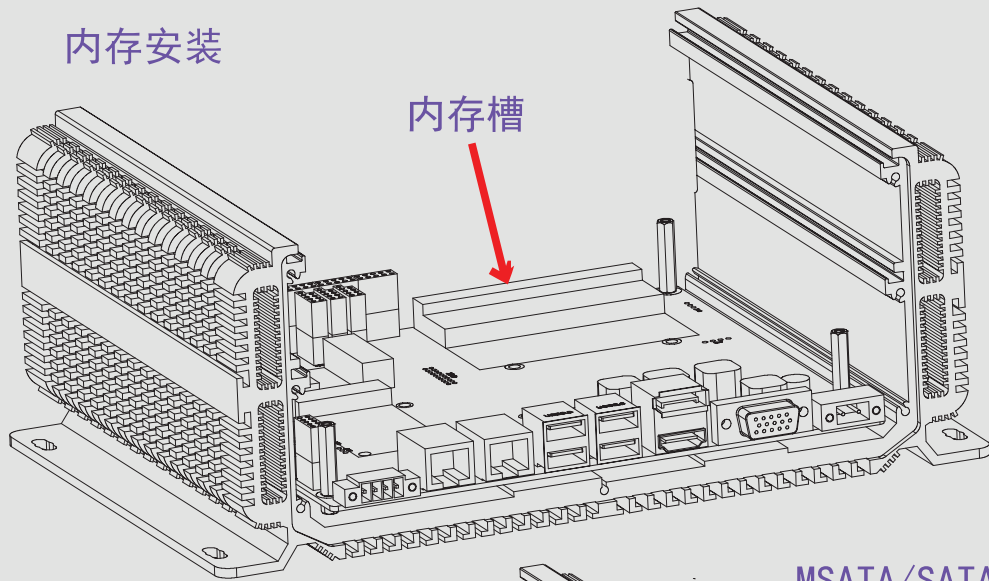

硬盘安装

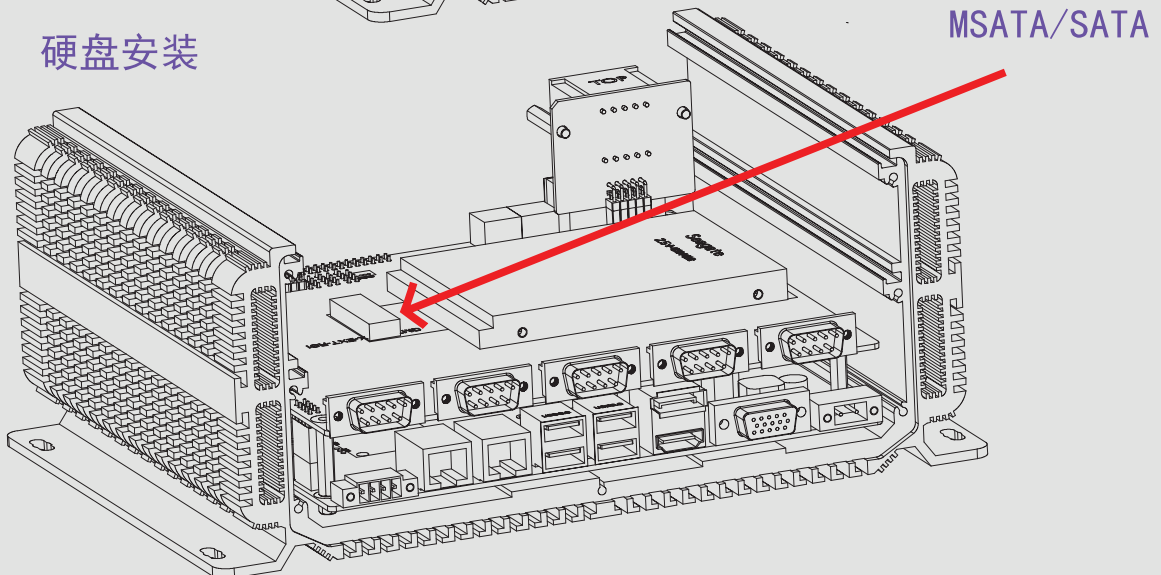

● 系统安装

产品支持多种操作系统，比如windows，unix，linux等，这里以windows操作系统为例做以简述。

操作系统安装方法分为：光盘安装、硬盘安装、优盘安装。

- 1). 光盘安装:电脑自带的光盘都是原版系统，市面上买的光盘一般都是ghost系统。自己选择合适的进行安装。
- 2). 硬盘安装:把系统镜像放在非系统盘里，原版系统点击setup，ghost版系统点击AUTORUN.exe根据提示即可安装。
只适合系统还可以使用但又想重装系统时使用！！
- 3). 优盘安装:首先要把优盘做成启动盘，可以用大白菜，老毛桃等软件进行制作，制作软件可在其官网下载. 优盘安装系统相比之下是最灵活的了，可以安装原版系统，也可以安装ghost系统，可以把系统镜像放在优盘里，也可以把系统镜像放在电脑硬盘的非系统盘里，很随意。具体不同情况下的安装步骤略有不同，可到百度、大白菜、老毛桃寻I找。

一键备份还原：网上先下载这类软件，它可以把C盘完全复制，就是克隆，放在电脑上，当自己的电脑系统出现故障，C盘垃圾太多，中病毒时就可以把计算机还原到上次备份时的状态，非常方便快捷。一键备份生成的gho文件隐藏在其他分区里，设置显示隐藏的文件就可看到，一般3G左右。

用优盘安装原版windows系统大概步骤：

- 1). 下载优盘启动盘制作软件，制作启动盘。
- 2). 下载windows原版系统镜像文件，下载后解压备用。可以放在优盘里，也可以放在电脑非系统盘里。
- 3). 开机进入bios设置，设置为优先从优盘启动。bios的进入和设置方法见此手册《常见功能设置》。
- 4). 插上优盘，启动电脑，进入启动盘操作界面，之后比较复杂，建议到大白菜等网站查看安装原版系统详细教程。
- 5). 系统安装完成之后需要安装驱动，最简单的方法是使用驱动精灵等软件自动安装驱动，可以先下载驱动精灵离线版备用，以防系统重装后没有网卡驱动上不了网，而无法继续进行。
- 6). 这时系统会有一些漏洞（bug）要进行修补，驱动精灵，360安全卫士等都能自动检测并修补。
- 7). 安装完毕。再装一些自己常用的软件就可以了。



● 常用功能设置

双显示设置:

通电开机后按住键盘Delete键进入BIOS，
用键上的“←↑↓→”四个光标选择到Chipset项目，
找到“Boot Display Device”进入项中可以设置多显输出。

分辨率设置:

Flat Panel Type “进入此项中可设各种分辨率”

通道设置:

Panel Specification “此项中可以设置18BIT和24BIT输出”
保存退出即可

硬盘优先启动:

通电开机后按住键盘Delete键进入BIOS，
用键上的“←↑↓→”四个光标选择到BOOT项目中，
找到“1ST Boot Device”此项中可以设置第一启动的驱动器。
保存退出即可

来电开机设置:

通电开机后按住键盘Delete键进入BIOS，
用键上的“←↑↓→”四个光标选择到Advanced项目中，
进入“Power Management Configuration”项里，

Restore AC Power Loss:

- 1、Power OFF 来电关机
- 2、Power ON 来电开机
- 3、Last State 保持掉电前的状态 保存退出即可



● Watchdog (看门狗编程地址)

```
#include <stdio.h>
#include <dos.h>
#include <bios.h>
#include <stdlib.h>
#include <string.h>

short SIOWTD_Setup(short irq, short ioid);
short SIOWTD_Disable();
short SIOWTD_Enable(short time, short unit);
void Start_config();

void interrupt isr(...);
void interrupt (* oldisr)(...);
short SetIndexData();
char time_unit=0;
short HardwareID;

int irq;
int minutes;
int tmp_reg;
int pm_base;
int INDEXP = 0x2e;
int DATAP = 0x2f;

int main(int argc, char * argv[])
{
    int irqvect;
    unsigned char flag;
    int regport;

    char * p_time_unit;
    char* unit_ms[2]={"Seconds", "Minutes"};
    //get pm_base
    SetIndexData(); //设置2E, 2F或4E, 4F
    Start_config(); //打开配置空间

    //*****
    printf("*****\n");
    printf("* Wathdog Test Program *\n");
    printf("* Support:W83627THF/THG/DHG/DHG-P/EHG/HF-AW/HG-AW 6776F *\n");
    printf("*****\n");
    //判断参数长度
    if(argc<4)
    {
        printf("Usage:627x irq time[1~255] time_unit[/s,/m]\n");
        printf("IRQ :3, 4, 5, 6, 7, 9, 10, 11, 12, 14, 15, 255(Reset)\n");
        return 0;
    }
    //*****
```



```
//判断参数是否合法
irq = atoi(argv[1]); //获取参数数组的第一个参数, 中断
minutes = atoi(argv[2]); //获取参数数组的第二个参数, 时间
p_time_unit=argv[3]; //获取参数数组的第三个参数, 时间模式, 秒/分

ATOI函数把数组中的字符串类型数据 直接 转换为数字类型

if(irq!=3 && irq!=4 && irq!=5 && irq!=6 && irq!=7
&& irq!=9 && irq!=10 && irq!=11 && irq!=12 && irq!=14 && irq!=15 && irq != 255)
{
printf("Irq No. is invalid!\n");
return 0;
}
if(minutes < 1 || minutes > 255)
{
printf("Error time! \n");
return 0;
}
if(!(strcmp(p_time_unit, "/s")&&strcmp(p_time_unit, "/S")))
time_unit=0;
else
if(!(strcmp(p_time_unit, "/m")&&strcmp(p_time_unit, "/M")))
time_unit=1;
else
{
printf("Error time unit!\n");
return 0;
}
//参数判断结束
//*****

//*****
SIOWTD_Setup(irq, HardwareID); //判断中断。中断为255时, 寄存器2D Bit0 为0
中断为其他时2D Bit0 为1并把中断号送至F7寄存器
//*****

if(irq != 255 )
{
if(irq>8)
{
irqvect=irq+0x68;
regport=0x1;
} //0~7号中断在第一个8259A寄存器上
else
{
irqvect=irq+0x08; //8-15号中断在第二个8259A寄存器上
regport=0x21;
}
}
```

```

disable();
    outportb(regport-1, 0x20); //首先使中断结束
    oldisr=getvect(irqvect); //保存当前中断向量表中的内容
    if(irq!=0) //合法IRQ
        setvect(irqvect, isr); //将要中断的函数地址或程序地址（ISR）付给IRQVECT的向量表
    flag=inportb(regport); //
    outportb(regport, 0);
    enable();
}
printf("\nPlease waiting %d %s or Press \"Enter\" to abort test\n", minutes, unit_ms[time_unit]);

SIOWTD_Disable();
SIOWTD_Enable(minutes, time_unit);
//*****
//循环等待键盘输入一个回车，输入回车就跳出循环
while(1)
{
    int key;
    //wait for 2*60 s=2'
    for(int i=0;i<60;i++)
    {
        if(bioskey(1))
        {
            key=bioskey(0)&0xff;
            if(key==13) //13回车
                break;
        }
        delay(100);
    }
    if(key==13)

        break;
    }

//*****
//restore interrupt enable register and ISR
SIOWTD_Disable();
if(irq != 255)
{
    outportb(regport, flag);
    setvect(irqvect, oldisr);
}
return 0;
}

void interrupt isr(...)
{
    printf("Interrupt is caused by Watchdog: IRQ%d\n", irq);
}
    
```

```

outputb(0x20, 0x20);          //告诉8259A中断结束
outputb(0xa0, 0x20);         //告诉8259A中断结束
SIOWTD_Disable();           //计数器归零
SIOWTD_Enable(minutes, time_unit); //设置WDT状态
}

short SetIndexData()          //设置ISA总线访问的索引寄存器，数据寄存器
{
    //一般来说该寄存器有两种2E，2F或者4E，4F这两组，

    根据DATASHEET定义打开配置空间要向2E扔两次87

    outputb(INDEXP, 0x87);
    outputb(INDEXP, 0x87);
    outputb(INDEXP, 0x20);     //20为83627芯片 CHIP ID，如果打开了配置空间则可以读到ID号，
                                //如未打开则ID号为FF，表示没有打开。

    HardwareID = inportb(DATAP);
    if (HardwareID==0xff)     //加入打开空间错误那么把2E，2F改为4E，4F
    {
        INDEXP= 0x4e;
        DATAP = 0x4f;
        outputb(INDEXP, 0x87); //进入4E，4F空间后读HardwareID以备后面使用。
        outputb(INDEXP, 0x87);
        outputb(INDEXP, 0x20);
        HardwareID = inportb(DATAP);
    }
    return 0;
}

void Start_config()
{
    //Enter config<<<<<
    outputb(INDEXP, 0x87);     //打开配置空间
    outputb(INDEXP, 0x87);

    //Enter config>>>>>

    outputb(INDEXP, 0x07);     //在配置空间的07位置
    outputb(DATAP, 0x08);     //把08给到07位置，表示打开逻辑设备08，

                                因为WDT的30，F5，F6，F7 寄存器都在8号逻辑设备上

    outputb(INDEXP, 0x30);     //把30寄存器改默认值00位01，打开WDT
    outputb(DATAP, 0x01);

    outputb(INDEXP, 0x2D);
    outputb(DATAP, 0x20);     //在2D寄存上我们先设置以WDT方式重起值为20，

                                值为2。设置系统重起使用GPIO模式，值为21。

    short SIOWTD_Setup(short irq1, short ioid)
    /* irq=3, 4, 5, 6, 7, 9, 12, 0:disable interrupt, 0xff(255):reset*/
    {
        printf("\nHardWareID: 0x%X, SuperIO:", ioid);
        switch(ioid)

```



```
{
//HardwareID: HDG = A0, EHG = 88, THG/THF = 82, HF/F/FG = 52, DHG HardwareID = A0      6776 HG HardwareID =0xC3:
case 0xB0:
{
if(irq1==0xff)
{
outportb(INDEXP, 0x2D); //寄存器2D bit0 = 0为复位, 1为WDT中断模式
outportb(DATAP, 0x20); //复位模式
}
else
{
outportb(INDEXP, 0x2D);
outportb(DATAP, 0x21); //中断模式
outportb(INDEXP, 0xF7);
outportb(DATAP, irq);
}
printf("W83627DHG-P\n");
break;
}

case 0xC3:
{
if(irq1==0xff)
{
outportb(INDEXP, 0x2D); //寄存器2D bit0 = 0为复位, 1为WDT中断模式
outportb(DATAP, 0x20); //复位模式
}
else
{
outportb(INDEXP, 0x2D);
outportb(DATAP, 0x21); //中断模式
outportb(INDEXP, 0xF7);

outportb(DATAP, irq);
}
printf("W83627EHG\n");
break;
}

case 0x82: //THG or THF HardwareID = 82
{
if(irq1==0xff)
{
outportb(INDEXP, 0x2B); //2B bit 2-3选择复位或者中断, bit2-3 = 01为中断, 00为复位
outportb(DATAP, 0x04);

}
else
{

outportb(INDEXP, 0x2B);
outportb(DATAP, 0x00); //选择中断模式
}
}
}
```



```
outportb(INDEXP, 0xF7);
    outportb(DATAP, irq);
    outportb(INDEXP, 0x07);
    outportb(DATAP, 0x09); //选择logic device9
    outportb(INDEXP, 0x30);
    outportb(DATAP, 0x01); //打开GPIO3 PORT
    outportb(INDEXP, 0xf2);
    outport (DATAP, 0x00); //不翻转电平
    unsigned char data;
    outportb(INDEXP, 0xf0);
    data=inportb (DATAP)&0xf7;
    outportb(DATAP, data); //reg0xf0 bit [3]=0, 选择GP33为GPO输出
    outportb(INDEXP, 0xf1);
    data=inportb (DATAP)&0xf7;
    outportb(DATAP, data); //reg0xf1 bit [3]=0, 选择GP33输出低电平
}
printf("W83627THG/THF\n");
break;
}
case 0x52: //HG or HF HardwareID =52
{
    if(irq1==0xff)
    {
        outportb(INDEXP, 0x2B); //2B bit 4选择复位或者中断, bit4 = 1为中断, 0为复位
        outportb(DATAP, 0x00);
    }
    else
    {
        outportb(INDEXP, 0x2B);
        outportb(DATAP, 0x10);
        outportb(INDEXP, 0xf2); //
        outport (DATAP, 0x00); //不翻转电平值
        unsigned char data;
        outportb(INDEXP, 0xf0);
        data=inportb (DATAP)&0xef;
        outportb(DATAP, data); //寄存器0xf0 bit [4]=0, 选择GP24为GPO
        outport (INDEXP, 0xf1);
        data=inportb (DATAP)&0xef;
        outportb(DATAP, data); //寄存器0xf1 bit [4]=0, 选择GP24输出低电平
        outportb(INDEXP, 0xF7); //选择中断
        outportb(DATAP, irq);
    }
    printf("W83627HF/F/FG\n");
    break;
}
default:
printf("The SuperIO is not W83627HF / THG / DHG / EHG / HF-AW / HG-AW,Please Chcekit and use the right program \n");
}
return 0;
}
```

```

/*
short HG_ID = 0x52;    //Super IO 为 HG-AW/HF-AW
short DHG_ID = 0xA0;   //Super IO 为 DHG
short EHG_ID = 0x88;   //Super IO 为 EHG
short CTR_ADD = 0x2D;  //DHG 复位及

//检查参数
//if(irq!=0xff && (irq<3 || irq>7) && irq!=9 && irq!=12 && irq!=0)
// return -1;
SIOWTD_Disable();
//start programming Watchdog

//Set Watchdog Event
if((irq==0xff)&&(ioid==DHG_ID) || (ioid==EHG_ID)) //WatchDog cause System Reset
{
    //如果值为255，也就是FF时，选择系统重起
    outportb(INDEXP, 0x2D); //DHG版本
    outportb(DATAP, 0x20); //set pin as Watchdog output
}
else if((irq==0xff)&&(ioid==HG_ID))
{
    CTR_ADD = 0x2B;
    outportb(INDEXP, CTR_ADD); //DHG版本
    outportb(DATAP, 0x00); //set pin as Watchdog output
    outportb(INDEXP, 0xF7); //HG版本
    outportb(DATAP, 0x00); //HG版本set pin as Watchdog output
}
else if((irq!=0xff)&&(ioid==HG_ID))
{
    CTR_ADD = 0x2B;
    outportb(INDEXP, CTR_ADD); //HG版本
    outportb(DATAP, 0x10); //HG版本set pin as GPIO
    irq=irq&0x0f;
    outportb(INDEXP, 0x0f7);
    outportb(DATAP, irq);
}
else//Watchdog cause System Interrupt //如果值为其他合法的IRQ，那么把该值放到F7寄存器，一般在F7的低四位。
{
    outportb(INDEXP, 0x2D);
    outportb(DATAP, 0x21); //set pin as GPIO
    irq=irq&0x0f;
    outportb(INDEXP, 0x0f7);
    outportb(DATAP, irq);
}
//end programming watchdog

return 0;
}
*/
short SIOWTD_Enable(short time, short unit)
/*unit=0:second, =1:minutes */
{
    if(time<1 || time>255) return -1;
    if(unit<0 || unit>1) return -1;
    //start programming watchdog

```



```
//select Watchdog Timer clock
switch(unit)
{
case 0:
//secondes
outportb(INDEXP, 0x07);
outportb(DATAP, 0x08);

outportb(INDEXP, 0xF5);
outportb(DATAP, 0x00);
break;
case 1:
//minutes
outportb(INDEXP, 0x07);
outportb(DATAP, 0x08);

outportb(INDEXP, 0xF5);
outportb(DATAP, 0x08);
break;
}
//set timeout value
outportb(INDEXP, 0xF6);
outportb(DATAP, time);
if (irq!=0xff)
{outportb(INDEXP, 0xF7);
outportb(DATAP, irq);
}
//end programming watchdog

return 0;
}
short SIOWTD_Disable() //初始化WDT的F6寄存器，该寄存器为记数寄存器，最大值为255或FF
{
//start programming watchdog

outportb(INDEXP, 0x07);
outportb(DATAP, 0x08);

outportb(INDEXP, 0xF6);
outportb(DATAP, 0x00);

return 0;
}
```



● GPIO程序代码

```
#include <io.h>
#include <stdio.h>
#include <stdlib.h>
#include <conio.h>
#include <dos.h>

/*****/
#define OPENPORT {outportb(INDEXP, 0x87);outportb(INDEXP, 0x87);}
unsigned char INDEXP= 0x2E;
unsigned char DATAP= 0x2F;
/*****/

/*****/
//ISA端口访问函数

char READ_ISA(unsigned char index); //从ISA端口读取一个数据
void WRITE_ISA(unsigned char index,unsigned char data);//向一个ISA端口写入数据

void main(void)
{
//int i; //循环变量
OPENPORT;

WRITE_ISA(0x2F, 0x01); //SET DSW_EN =0;
WRITE_ISA(0x07, 0x09); //跳换到09逻辑设备
WRITE_ISA(0x30, 0x1C); //SETGPIO2 3 4
WRITE_ISA(0xE4, 0x9F); //SET GPI/O DIR
WRITE_ISA(0xF0, 0x3F); //SET GPI/O DIR
WRITE_ISA(0xE0, 0xFF); //SET GPI/O DIR

//while(inportb(0x60)!=0x01) //d loop
{
WRITE_ISA(0xF1, 0xC0); //SET GPO 46 47 IS HIGH
WRITE_ISA(0xE5, 0x60); //SET GPO 36 35 IS HIGH
sleep(2);
//READ_ISA(0xE1)//gpio2 value
//////////gpio37
if((READ_ISA(0xE5))&(0x80))
{
printf("GPIO1-2 is Good\n");
}
else
{
printf("GPIO1-2 is error\n");
}
}
```



```
//////////gpio27
if((READ_ISA(0xE1))&(0x80))
{
printf("GPIO3-4 is Good\n");
}
else
{
printf("GPIO3-4 is error\n");
}

//////////gpio24
if((READ_ISA(0xE1))&(0x10))
{
printf("GPIO5-6 is Good\n");
}
else
{
printf("GPIO5-6 is error\n");
}

//////////gpio31
if((READ_ISA(0xE5))&(0x02))
{

printf("GPIO7-8 is Good\n");
}
else
{
printf("GPIO7-8 is error\n\n");
}
//////////
WRITE_ISA(0xF1,0x00); //SET GPO 46 47 IS LOW
WRITE_ISA(0xE5,0x00); //SET GPO 36 35 IS LOW
sleep(1);
//////////
//////////gpio37
if((READ_ISA(0xE5))&(0x80))
{
printf("GPIO1-2 is error\n");
}
else
{
printf("GPIO1-2 is Good\n");
}

//////////gpio27
if((READ_ISA(0xE1))&(0x08))
{
printf("GPIO3-4 is error\n");
}
```



```
}
else
{
printf("GPIO3-4 is Good\n");
}

//////////gpio24
if((READ_ISA(0xE1)&(0x10))
{
printf("GPIO5-6 is error\n");
}
else
{
printf("GPIO5-6 is Good\n");
}

//////////gpio31
if((READ_ISA(0xE5)&(0x02))
{
printf("GPIO7-8 is error\n");
}
else
{
printf("GPIO7-8 is Good\n");
}
}
//////////
}
//测试失败程序返回1
}

/*****
函数名: READ_ISA(unsigned char index)
输入参数:index为地址,data保存为从index中读出的地址
返回值 :data 为地址中数据
函数功能:从一个ISA端口中读取数据
*****/
char READ_ISA(unsigned char index)
{
unsigned char data;
//OPENPORT;
outportb(INDEXP, index);
data=inportb(DATAP);
return data;
}

/*****
函数名: WRITE_ISA(unsigned char index,unsigned char data)
输入参数:index为地址,data保存为从index中读出的地址
返回值
函数功能:向一个ISA端口中写入数据
*****/
void WRITE_ISA(unsigned char index,unsigned char data)
{
//OPENPORT;
outportb(INDEXP, index);
outportb(DATAP, data);
}
```

BIOS设置

简介

本部分描述如何运用BIOS配置程序设置您的系统。正确设置BIOS各项参数可使系统稳定可靠地工作，同时也能提升系统的整体性能，不恰当的甚至错误的BIOS系统工作性能大为降低，使系统工作不稳定甚至无法正常工作。

当系统接通电源，正常开机后可看见进入BIOS设置程序提示的信息，此时其它时间无效按下提示信息所指定的按键（通常为键）即可进入BIOS设置程序。CMOS中BIOS设置内容被破坏时系统也会要求进入BIOS设置程序，通过BIOS修改的所有设置值也都保存在系统的CMOS存储器中，该CMOS存储器由电池供电，即使切断外部电源其内容也不会丢失，除非执行清除CMOS内容的操作。

一旦您进入了AMIBIOS设定程序，屏幕上会显示出主菜单。主菜单共提供了六种设定功能和两种退出选择。用户可以通过方向键选择功能项目，按Enter 键进入子菜单。

<↑>向前移一项；<↓>向后移一项；<←>向左移一项；

<→>向右移一项；<Enter>确定选择此选项；

<ESC>跳到退出菜单或者从子菜单回到主菜单

<F1>主题帮助，仅在状态显示菜单和选择设定菜单有效

<F7>放弃设置但是不退出 BIOS；

<F8>载入故障安全缺省值

<F9>载入优化缺省值

<F10> 保存并退出

设置方法：使用方向键移动白色高亮光标至设定处，按回车键进入设定菜单。

Main (BIOS主界面)

当您进入 BIOS 设置程序时，主界面将会显现并显示系统概况。主菜单顶部显示的是控制菜单的控制菜单的控制键主菜单的中部显示的是当前所选，第一个控制菜单的内容灰色信息是只读的内存及CPU信息。根据用户系统配置的改变自动调整。菜单右下部是本菜单所用的控制键如果您需要帮助，按<F1>将显示相关信息帮助您。



System Date / System Time

日期和时间修改项



Advanced (高级BIOS设置)

此组选项设置系统的基本硬件配置。

Aptio Setup Utility - Copyright (C) 2012 American Megatrends, Inc.	
Main	Advanced
<ul style="list-style-type: none"> ▶ Trusted computing ■ CPU Configuration ■ SATA Configuration ■ Intel TXT(LT) Configuration ■ PCH-FW Configuration ■ AMT Configuration ■ USB Configuration ■ Second Super IO Configuration ■ Super IO Configuration ■ H/W Monitor ■ CPU PPM Configuration 	<p>Trusted Computing settings</p> <hr/> <p>→ ←: Select Screen ↑ ↓: Select Item Enter: Select +/-: Change Opt. F1: General Help F2: Previous Values F3: Optimized Defaults F4: Save & Exit ESC: Exit</p>
Version 2.15.1227. Copyright (C) 2012 American Megatrends, Inc.	

Trusted computing

This section configures settings relevant to Trusted Computing innovations.

Aptio Setup Utility - Copyright (C) 2011 American Megatrends, Inc.	
Advanced	
<p>Configuration</p> <p>Security Device Support [Disabled]</p> <p>Current Status Information</p> <p>SUPPORT TURNED OFF</p>	<p>Enables or Disables BIOS support for security device. O.S. will not show Security Device. TCG EFI protocol and INT1A interface will not be available.</p> <hr/> <p>→ ←: Select Screen ↑ ↓: Select Item Enter: Select +/-: Change Opt. F1: General Help F2: Previous Values F3: Optimized Defaults F4: Save & Exit ESC: Exit</p>
Version 2.14.1219. Copyright (C) 2011 American Megatrends, Inc.	

Security Device Support

Enables or Disables BIOS support for security device. O.S. will not show SecurityDevice. TCG EFI protocol and INT1A interface will not be available.



CPU Configuration

This section is used to configure the CPU. It will also display the detected CPU information.

Aptio Setup Utility - Copyright (C) 2011 American Megatrends, Inc.		
Advanced		
CPU Configuration		Enabled for Windows XP and Linux (OS optimized for Hyper-Threading Technology) and Disabled for other OS (OS not optimized for Hyper-Threading Technology). When Disabled only one thread per enabled core is enabled.
Intel (R) Core (TM) i7-2710QE CPU @ 2.10GHz		
CPU Signature	206a7	→ ←: Select Screen ↑ ↓: Select Item Enter: Select +/-: Change Opt. F1: General Help F2: Previous Values F3: Optimized Defaults F4: Save & Exit ESC: Exit
Microcode Patch	25	
Max CPU Speed	2300 MHz	
Min CPU Speed	1200 MHz	
CPU Speed	2300 MHz	
Processor Cores	4	
Intel HT Technology	Supported	
Intel VT-x Technology	Supported	
Intel SMX Technology	Supported	
64-bit	Supported	
L1 Data Cache	32 kB x 4	
L1 Code Cache	32 kB x 4	
L2 Cache	256kB x 4	
L3 Cache	6144 kB	
Hyper-threading	[Enabled]	
Active Processor Cores	[All]	
Intel Virtualization Technology	[Disabled]	

Version 2.14.1219. Copyright (C) 2011 American Megatrends, Inc.

Hyper-threading

Enable this field for Windows XP and Linux which are optimized for Hyper-Threading technology. Select disabled for other OSes not optimized for Hyper-Threading technology. When disabled, only one thread per enabled core is enabled.

Active Processor Cores

Number of cores to enable in each processor package.

Intel Virtualization Technology

When this field is set to Enabled, the VMM can utilize the additional hardware capabilities provided by Vanderpool Technology.

SATA Configuration

This section is used to configure the CPU. It will also display the detected CPU information.

Aptio Setup Utility - Copyright (C) 2011 American Megatrends, Inc.		
Advanced		
SATA Controller(s)	[Enabled]	Enable or disable SATA Device.
SATA Mode Selection	[IDE]	
Aggressive LPM Support	[Enabled]	
SATA Controller Speed	[Gen2]	
IDE Legacy / Native Mode Selection	[Native]	
Serial ATA Port 0	Empty	→ ←: Select Screen ↑ ↓: Select Item Enter: Select +/-: Change Opt. F1: General Help F2: Previous Values F3: Optimized Defaults F4: Save & Exit ESC: Exit
Software Preserve	Unknown	
Serial ATA Port 1	Empty	
Software Preserve	Unknown	
Serial ATA Port 2	Empty	
Software Preserve	Unknown	
Serial ATA Port 3	Empty	
Software Preserve	Unknown	
Serial ATA Port 4	Empty	
Software Preserve	Unknown	
Serial ATA Port 5	Empty	
Software Preserve	Unknown	

Version 2.14.1219. Copyright (C) 2011 American Megatrends, Inc.

SATA Controller(s)

This field is used to enable or disable the Serial ATA channels.

SATA Mode Selection

IDE Mode

This option configures the Serial ATA drives as Parallel ATA storage devices.

AHCI Mode

This option allows the Serial ATA devices to use AHCI (Advanced Host Controller Interface).

RAID Mode

This option allows you to create RAID or Intel Matrix Storage configuration on Serial ATA devices. If AHCI or RAID is selected in the SATA Mode Selection, it will display the following information:

Aggressive LPM Support

This option configures the Serial ATA drives as Parallel ATA to aggressively enter link power state. TA storage devices.

Intel TXT (LT) Configuration

This section is used to configure the Intel Trusted Execution technology.

Aptio Setup Utility - Copyright (C) 2011 American Megatrends, Inc.	
Advanced	
Intel Trusted Execution Technology Configuration	
Intel TXT support only can be enabled/disabled if SMX is enabled. VT and VT-d support must also be enabled prior to TXT.	
Secure Mode Extension (SMX)	Enabled
Intel TXT(LT) Support	[Disabled]
→←: Select Screen ↑↓: Select Item Enter: Select +/-: Change Opt. F1: General Help F2: Previous Values F3: Optimized Defaults F4: Save & Exit ESC: Exit	
Version 2.14.1219. Copyright (C) 2011 American Megatrends, Inc.	

Secure Mode Extensions (SMX)

The options are Enabled and Disabled.

Intel TXT(LT) Support

The options are Enabled and Disabled.



PCH-FW Configuration

This section is used to configure the Intel Trusted Execution technology.

Aptio Setup Utility - Copyright (C) 2011 American Megatrends, Inc.

Advanced

ME FW Version 8.0.3. 1502 ME Firmware Mode Normal Mode ME Firmware Type Full Sku Firmware ME Firmware SKU Unidentified	→ ←: Select Screen ↑ ↓: Select Item Enter: Select +/-: Change Opt. F1: General Help F2: Previous Values F3: Optimized Defaults F4: Save & Exit ESC: Exit
--	--

Version 2.14.1219. Copyright (C) 2011 American Megatrends, Inc.

Intel AMT Configuration

Aptio Setup Utility - Copyright (C) 2011 American Megatrends, Inc.

Advanced

Intel AMT [Enabled] Disable ME [Disabled] Un-Configure ME [Disabled]	Enable/ Disable Intel (R) Active Management Technology BIOS Extension. Note: iAMT H/W is always enabled. This option just controls the BIOS extension execution. If enabled, this requires additional firmware in the SPI device.
	→ ←: Select Screen ↑ ↓: Select Item Enter: Select +/-: Change Opt. F1: General Help F2: Previous Values F3: Optimized Defaults F4: Save & Exit ESC: Exit

Version 2.14.1219. Copyright (C) 2011 American Megatrends, Inc.

Intel AMT

Enables or disables the AMT function.

Un-Configure ME

Select Enabled to unconfigure the ME function without the need for a password.



USB Configuration

Aptio Setup Utility - Copyright (C) 2011 American Megatrends, Inc.

Advanced

USB Configuration USB Devices: 1 Keyboard, 1 mouse, 2 Hubs Legacy USB Support [Enabled]	Enables Legacy USB support. AUTO option disables legacy support if no USB devices are connected. DISABLE option will keep USB devices available only for EFI applications.
→ ←: Select Screen ↑↓: Select Item Enter: Select +/-: Change Opt. F1: General Help F2: Previous Values F3: Optimized Defaults F4: Save & Exit ESC: Exit	

Version 2.14.1219. Copyright (C) 2011 American Megatrends, Inc.

Legacy USB Support

Enabled

Enables legacy USB.

Auto

Disables support for legacy when no USB devices are connected.

Disabled

Keeps USB devices available only for EFI applications.

Second Super IO Configuration

This section is used to configure the serial port functions.

Aptio Setup Utility - Copyright (C) 2012 American Megatrends, Inc.

Advanced

Second Super IO Configuration Second Super IO Chip 2 Fintek F81216D <input checked="" type="checkbox"/> Serial Port 3 Configuration <input checked="" type="checkbox"/> Serial Port 4 Configuration <input checked="" type="checkbox"/> Serial Port 5 Configuration <input checked="" type="checkbox"/> Serial Port 6 Configuration	Set Parameters of Serial Port 4 (COMB)
→ ←: Select Screen ↑↓: Select Item Enter: Select +/-: Change Opt. F1: General Help F2: Previous Values F3: Optimized Defaults F4: Save & Exit ESC: Exit	

Version 2.15.1227. Copyright (C) 2012 American Megatrends, Inc.

Serial Port 3 Configuration to Serial Port 6 Configuration

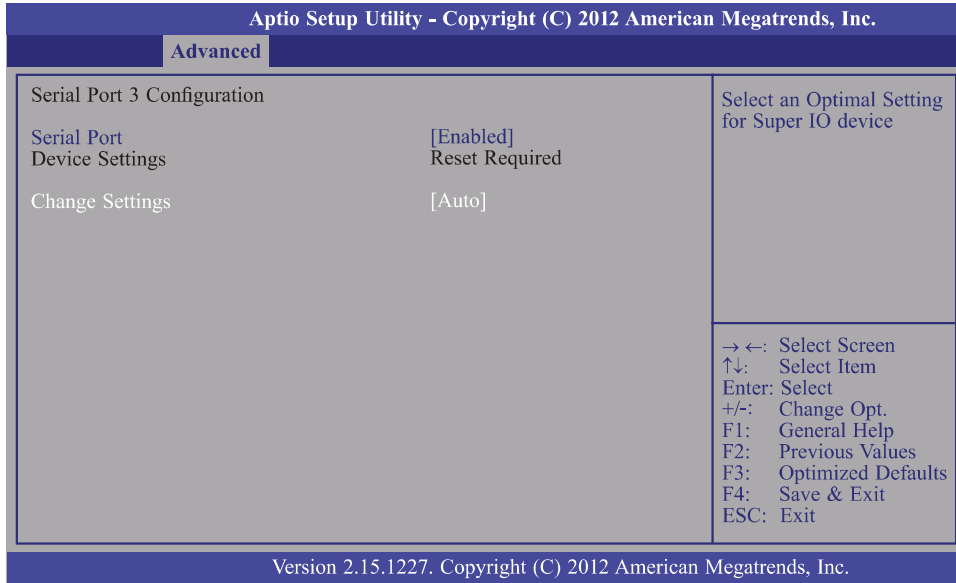

Serial Port

Enables or disables the serial port.

Change Settings

Selects the IO/IRQ setting of the I/O device.

Super IO Configuration

This section is used to configure the I/O functions supported by the onboard Super I/O chip.

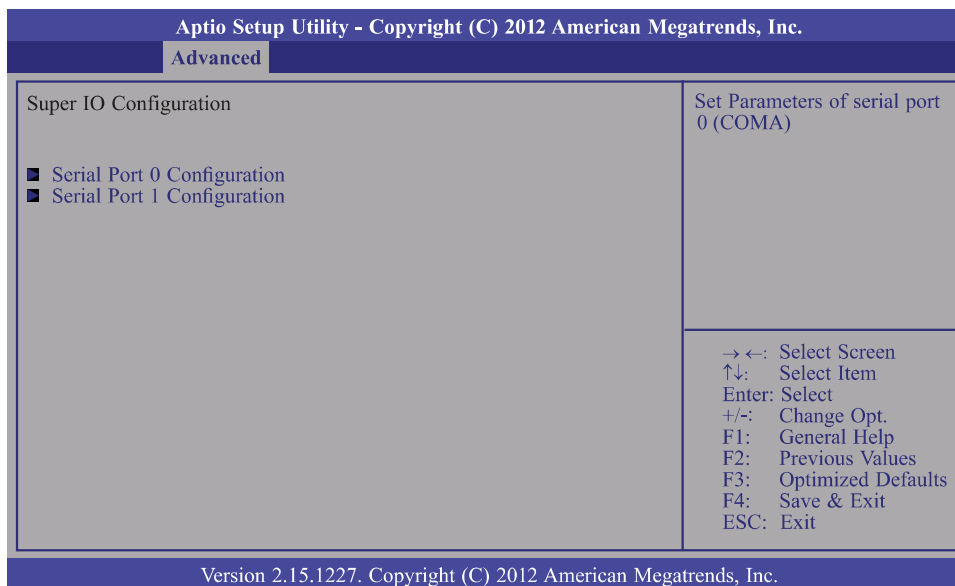

Serial Port 0 Configuration to Serial Port 2 Configuration

Enables or disables the serial port.



Aptio Setup Utility - Copyright (C) 2012 American Megatrends, Inc.

Advanced

Serial Port 0 Configuration		Enable or Disable Serial Port (COM)
Serial Port	[Enabled]	
Device Settings	IO=3F8h; IRQ=4;	
Change Settings	[Auto]	→ ←: Select Screen ↑ ↓: Select Item Enter: Select +/-: Change Opt. F1: General Help F2: Previous Values F3: Optimized Defaults F4: Save & Exit ESC: Exit

Version 2.15.1227. Copyright (C) 2012 American Megatrends, Inc.

Aptio Setup Utility - Copyright (C) 2012 American Megatrends, Inc.

Advanced

Serial Port 1 Configuration		Enable or Disable Serial Port (COM)
Serial Port	[Enabled]	
Device Settings	IO=2F8h; IRQ=3;	
Change Settings	[Auto]	→ ←: Select Screen ↑ ↓: Select Item Enter: Select +/-: Change Opt. F1: General Help F2: Previous Values F3: Optimized Defaults F4: Save & Exit ESC: Exit

Version 2.15.1227. Copyright (C) 2012 American Megatrends, Inc.

Serial Port

Enables or disables the serial port.

Change Settings

Selects the IO/IRQ setting of the I/O device.

CPU PPM Configuration

This section is used to configure the I/O functions supported by the onboard Super I/O chip.

Aptio Setup Utility - Copyright (C) 2012 American Megatrends, Inc.

Advanced

CPU PPM Configuration		Enable/Disable Intel SpeedStep
EIST	[Enabled]	
Turbo Mode	[Enabled]	
		→ ←: Select Screen ↑ ↓: Select Item Enter: Select +/-: Change Opt. F1: General Help F2: Previous Values F3: Optimized Defaults F4: Save & Exit ESC: Exit

Version 2.15.1227. Copyright (C) 2012 American Megatrends, Inc.



EIST

EnabThis fi eld is used to enable or disable the Intel Enhanced SpeedStep Technologyles or disables the serial port.

Turbo Mode

The options are Enabled and Disabled.

Chipset

Confi gures relevant chipset functions.

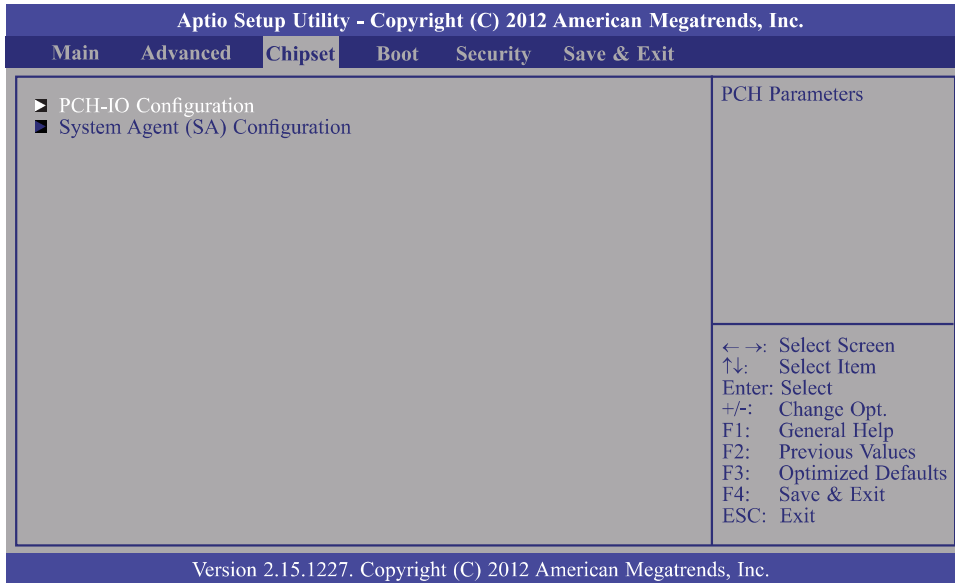

PCH-IO Confi guration

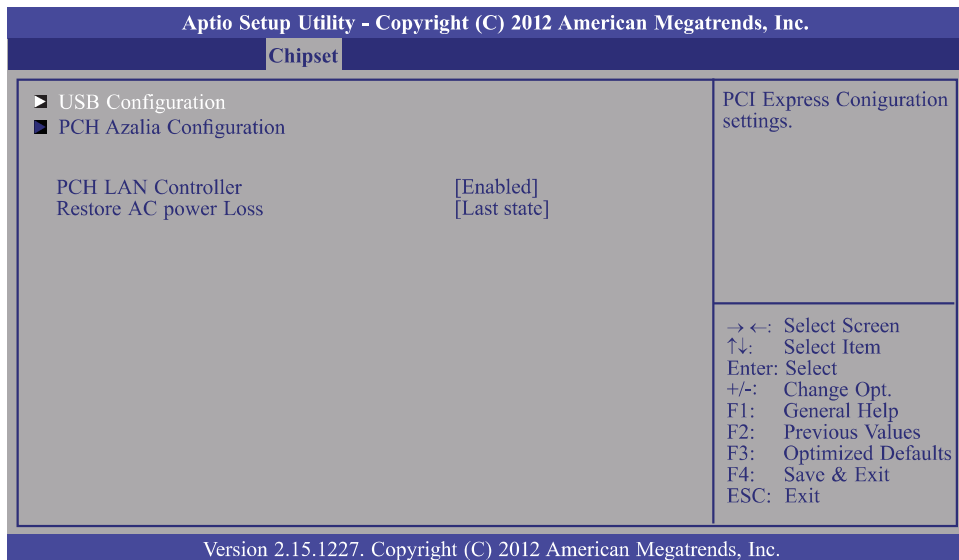

PCH LAN Controller

Enables or disables the PCH LAN Controller.

Restore AC power Loss

Power Off / Power On / Last State



USB Configuration

Aptio Setup Utility - Copyright (C) 2012 American Megatrends, Inc.		
Chipset		
USB Configuration		Enable or disable xHCI pre-boot driver support.
XHCI Pre-Boot Driver	[Enabled]	→ ←: Select Screen ↑↓: Select Item Enter: Select +/-: Change Opt. F1: General Help F2: Previous Values F3: Optimized Defaults F4: Save & Exit ESC: Exit
xHCI Mode	[Smart Auto]	
HS Port #1 Switchable	[Enabled]	
HS Port #2 Switchable	[Enabled]	
HS Port #3 Switchable	[Enabled]	
HS Port #4 Switchable	[Enabled]	
xHCI Streams	[Enabled]	
EHCI1	[Enabled]	
EHCI2	[Enabled]	
USB Ports Per-Port Disable Control	[Disabled]	
Version 2.15.1227. Copyright (C) 2012 American Megatrends, Inc.		

xHCI Pre-Boot Driver

Enables or disables xHCI Pre-Boot Driver support.

xHCI Mode

Mode of operation of xHCI controller. Options are Smart Auto, Auto, Enabled, Disabled.

EHCI1 and EHCI2

These fields are used to enable or disable USB 2.0.

PCH Azalia Configuration

Aptio Setup Utility - Copyright (C) 2012 American Megatrends, Inc.		
Chipset		
PCH Azalia Configuration		Control detection of the Azalia device. Disable= Azalia will be unconditionally disabled Enabled= Azalia will be unconditionally enabled Auto=Azalia will be enabled if present, disabled otherwise.
Azalia	[Auto]	→ ←: Select Screen ↑↓: Select Item Enter: Select +/-: Change Opt. F1: General Help F2: Previous Values F3: Optimized Defaults F4: Save & Exit ESC: Exit
Azalia Internal HDMI Codec	[Enabled]	
Azalia HDMI Code Port B	[Enabled]	
Azalia HDMI Code Port C	[Enabled]	
Azalia HDMI Code Port D	[Enabled]	
Version 2.15.1227. Copyright (C) 2012 American Megatrends, Inc.		

Azalia internal HDMI codec

Enables or disables the Azalia internal HDMI codec.

xHCI Mode

Mode of operation of xHCI controller. Options are Smart Auto, Auto, Enabled, Disabled.

EHCI1 and EHCI2

These fields are used to enable or disable USB 2.0.



System Agent (SA) Configuration

Aptio Setup Utility - Copyright (C) 2012 American Megatrends, Inc.

Chipset

VT-d [Enabled]	Config Graphics Settings.
<ul style="list-style-type: none"> ▶ Graphics Configuration 	<ul style="list-style-type: none"> → ←: Select Screen ↑↓: Select Item Enter: Select +/-: Change Opt. F1: General Help F2: Previous Values F3: Optimized Defaults F4: Save & Exit ESC: Exit

Version 2.15.1227. Copyright (C) 2012 American Megatrends, Inc.

Graphics Configuration

Aptio Setup Utility - Copyright (C) 2012 American Megatrends, Inc.

Chipset

<ul style="list-style-type: none"> Primary Display [Auto] Internal Graphics [Auto] DVMT Pre-Allocated [64M] DVMT Total Gfx Mem [256M] ■ LCD Control 	<p>Select DVMT5.0 Total Graphic Memory size used by the Internal Graphics Device.</p> <ul style="list-style-type: none"> → ←: Select Screen ↑↓: Select Item Enter: Select +/-: Change Opt. F1: General Help F2: Previous Values F3: Optimized Defaults F4: Save & Exit ESC: Exit
--	---

Version 2.15.1227. Copyright (C) 2012 American Megatrends, Inc.

Primary Display

- Auto** When the system boots, it will auto detects the display de-vice
- IGFX** When the system boots, it will fi rst initialize the onboard VGA
- PEG** When the system boots, it will fi rst initialize the PCI Express x16 graphics card.

DVMT Total Gfx Mem

This field is used to select the graphics memory size used by DVMT mode.



LCD Control

Aptio Setup Utility - Copyright (C) 2012 American Megatrends, Inc.		
Chipset		
LCD Control		Select the Video Device which will be activated during POST. This has no effect if external graphics present.
Primary IGFX Boot Display	[CRT]	Secondary boot display selection will appear based on your selection.
Secondary IGFX Boot Display	[LVDS]	VGA modes will be supported only on primary display.
LCD Panel Type	[800 x 600 LVDS]	
Active LFP	[Int - LVDS]	
Panel Color Depth	[18 Bit]	
		→ ←: Select Screen ↑↓: Select Item Enter: Select +/-: Change Opt. F1: General Help F2: Previous Values F3: Optimized Defaults F4: Save & Exit ESC: Exit
Version 2.15.1227. Copyright (C) 2012 American Megatrends, Inc.		

Primary IGFX Boot Display and Secondary IGFX Boot Display

CRT / DP / LVDS / HDMI

Secondary IGFX Boot Display

Disabled / CRT / DP / LVDS / HDMI

LCD Panel Type

LVDS分辨率设置, 最高支持2048 X 1536

Active LFP

NO LVDS / Int-LVDS / SDVO LVDS / eDP Port-A / eDP Port-D

Panel Color Depth

LVDS 18Bit / 24Bit 设置

Boot

Aptio Setup Utility - Copyright (C) 2012 American Megatrends, Inc.					
Main	Advanced	Chipset	Boot	Security	Save & Exit
Boot Configuration				Number of seconds to wait for setup activation key. 65535(0xFFFF) means indefinite waiting.	
Setup Prompt Timeout			[1]		
Bootup NumLock State			[On]		
Quiet Boot			[Disabled]		
Fast Boot			[Disabled]		
Boot Option Priorities				← →: Select Screen ↑↓: Select Item Enter: Select +/-: Change Opt. F1: General Help F2: Previous Values F3: Optimized Defaults F4: Save & Exit ESC: Exit	
Boot Option #1			[SATA SM]		
Hard Drive BBS Parameters					
Version 2.15.1227. Copyright (C) 2012 American Megatrends, Inc.					

Setup Prompt Timeout

Selects the number of seconds to wait for the setup activation key. 65535(0xFFFF) denotes indefinite waiting.

Bootup NumLock State

This allows you to determine the default state of the numeric keypad. By default, the system boots up with NumLock on wherein the function of the numeric keypad is the number keys. When set to Off, the function of the numeric keypad is the arrow keys.



Quiet Boot

Enables or disables the quiet boot function

Fast Boot

Enables or disables boot with initialization of a minimal set of devices required to launch active boot option. Has no effect for BBS boot options.

Security

Aptio Setup Utility - Copyright (C) 2012 American Megatrends, Inc.					
Main	Advanced	Chipset	Boot	Security	Save & Exit
Password Description If ONLY the Administrator's password is set, then this only limits access to Setup and is only asked for when entering Setup. If ONLY the User's password is set, then this is a power on password and must be entered to boot or enter Setup. In Setup the User will have Administrator rights. The password length must be in the following range: Minimum length Maximum length Administrator Password HDD Security Configuration HDD SanDisk PSSD HDD Security Configuration				Set Administrator Password. → ←: Select Screen ↑↓: Select Item Enter: Select +/-: Change Opt. F1: General Help F2: Previous Values F3: Optimized Defaults F4: Save & Exit ESC: Exit	
Version 2.15.1227. Copyright (C) 2012 American Megatrends, Inc.					

Save & Exit

Aptio Setup Utility - Copyright (C) 2012 American Megatrends, Inc.					
Main	Advanced	Chipset	Boot	Security	Save & Exit
Save Changes and Reset Discard Changes and Exit Save Changes and Reset Discard Changes and Reset Save Options Save Changes Discard Changes Boot Override SATA SM: SanDisk PSSD-S2 16GB Launch EFI Shell from filesystem device				Reset the system after saving the changes. ← →: Select Screen ↑↓: Select Item Enter: Select +/-: Change Opt. F1: General Help F2: Previous Values F3: Optimized Defaults F4: Save & Exit ESC: Exit	
Version 2.15.1227. Copyright (C) 2012 American Megatrends, Inc.					

=====
完
=====